

CALIBRE – KALIBER – CALIBRE 1128A

Calibre de base 1120 – Basis Kaliber 1120 – Basic calibre 1120

<p style="text-align: center;">111/2 “““ ø 25,60 mm</p>	
<p>HAUTEUR sur mouvement HÖHE auf Uhrwerk HEIGHT on movement</p>	<p style="text-align: center;">5.05 mm</p>
<p>Réserve de marche / Gangreserve / Power reserve Nombre de rubis / Anzahl Rubine / Number of jewels Fréquence / Frequenz / Frequency Angle de levée / Hebungswinkel der Unruh / Angle of lift</p>	<p style="text-align: center;">44 h 23 4 Hz (28'800 A/h) 51°</p>

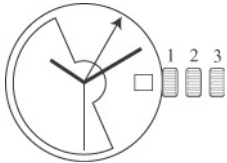
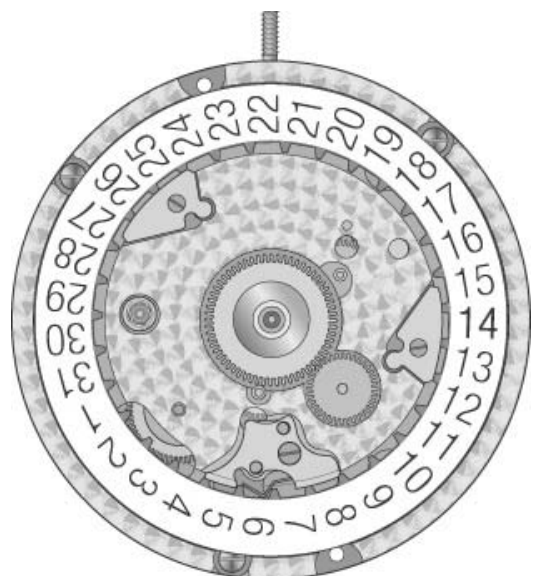
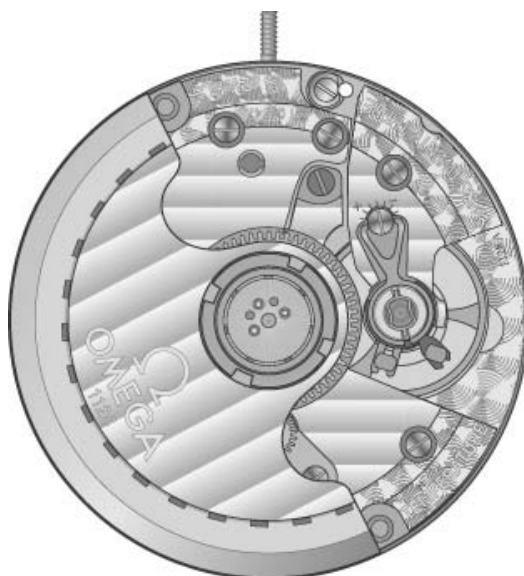

GMT

Français
Deutsch
English

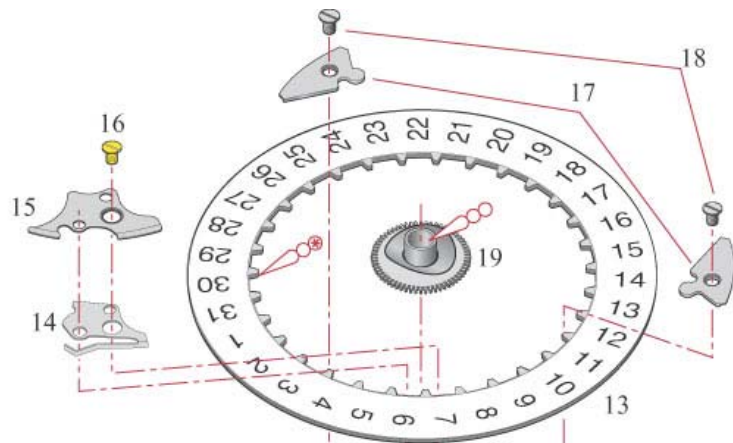

Liste des fournitures par ordre d'assemblage
Bestandteilliste in Montager Reihenfolge
Parts listed in order of assembly

1 = 31.083	11 = 16.010.06
2 = 31.041	12 = 3502
3 = 31.100	13 = 91.440
4 = 31.101 (1120)	14 = 53.080
5 = 10.062	15 = 13.111
6 = 10.062.01 (1120)	16 = 3501
7 = 31.101	17 = 13.105 (2x)
8 = 33.032	18 = 3500
9 = 31.046	19 = 31.047.06
10 = 33.014	





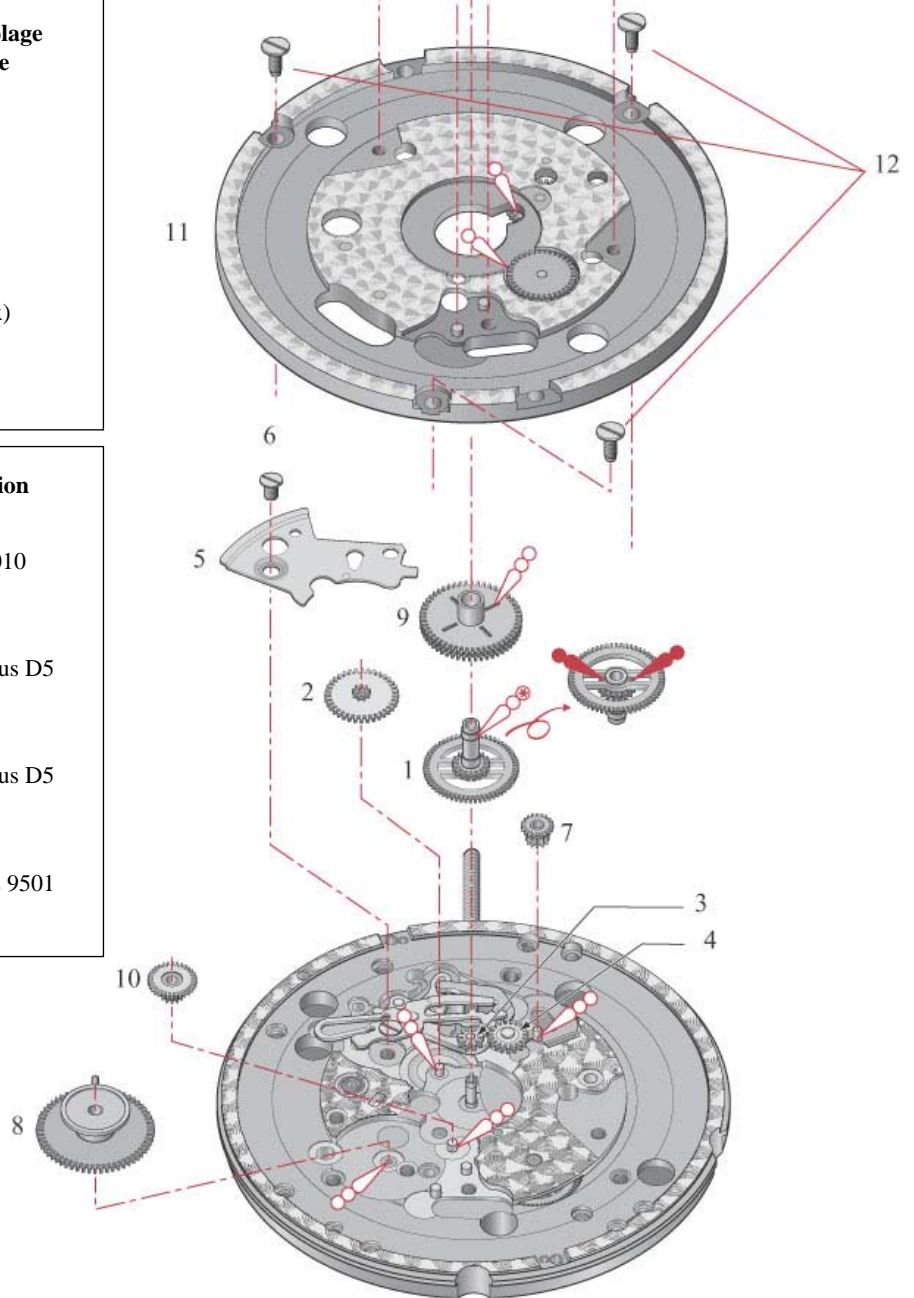





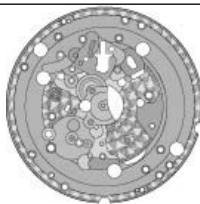



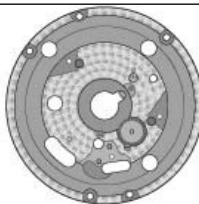







Lubrification – Schmierung – Lubrication

	Huile fine Dünflüssiges Öl Fine Oil	Moebius 9010
	Huile épaisse ou graisse Dickflüssiges Öl oder Fett Thick oil or grease	Moebius D5
	Très faible quantité Sehr kleine Menge Very little lubrication	Moebius D5
	Graisse Fett Grease	Moebius 9501



Remarque: Tous les autres composants sont identiques au calibre de base 1120. Voir guide technique du calibre 1120.
 Bemerkung: Alle anderen Teile sind identisch mit dem Basiskaliber 1120. Siehe technische Anleitung Kaliber 1120.
 Remark: All other components are identical with the basic calibre 1120. See technical guide calibre 1120.

Listes des fournitures – Bestandteilliste – Spare parts list

																						3500	3501	3502
10.020.07	10.062	13.105	13.111	16.010.06	22.010.06	30.027	31.041	31.046	31.047.06	31.083	31.100	31.101	31.120	31.121	33.014	33.032	51.010.21	51.080.06	53.022	53.080	91.440	3500	3501	3502

Cal.	No CS	SAV	Désignation	Bezeichnung	Designation
1128	10.020.07	100	Platine, empierrée	Werkplatte, mit Steinen	Main plate, jewelled
1128	10.062	462	Pont du rouage de minuterie	Wechselradbrücke	Minute train bridge
1128	13.105	2535	2x Plaque de maintien de l'indicateur de quantième	Halteplatte für Datumanzeiger	Date indicator maintaining plate
1128	13.111	2595	Plaque de maintien du sautoir de quantième	Halteplatte für Datumraste	Date jumper maintaining plate
1128	16.010.06	9448/1	Planche du mécanisme d'affichage, montée	Gestell Zeitanzeigermechanismus, montiert	Display mechanism platform, assembled
1128	22.010.06	1143/1	Masse oscillante, montée	Schwungmasse, montiert	Oscillating weight, assembled
1128	30.027	227	Roue de seconde	Sekundenrad	Second wheel
1128	31.041	260	Roue de minuterie	Wechselrad	Minute wheel
1128	31.046	250	Roue des heures	Stundenrad	Hour wheel
1128	31.047.06	251/1	Roue des heures 24 heures, montée	Stundenrad für 24 Stunden, montiert	Hour wheel for 24 hours, assembled
1128	31.083	242/1	Chaussée avec roue entraîneuse	Minutenrohr mit Mitnehmerrad	Cannon pinion with driving wheel
1128	31.100	450	Renvoi	Zeigerstellrad	Setting wheel
1128	31.101	453	Renvoi intermédiaire	Zwischen-Zeigerstellrad	Intermediate setting wheel
1128	31.120	410	Pignon de remontoir	Kupplungsrad	Winding pinion
1128	31.121	407	Pignon coulant	Kupplungstrieb	Sliding pinion
1128	33.014	2543	Roue intermédiaire de quantième	Datum-Zwischenrad	Intermediate date wheel
1128	33.032	2802	Roue de quantième	Datumrad	Date wheel
1128	51.010.21	401	Tige de remontoir	Aufzugwelle	Winding stem
1128	51.080.06	443/1	Tirette, montée	Winkelhebel, montiert	Setting lever, mounted
1128	53.022	2539	Commande du correcteur de quantième	Schalthebel für Datumkorrektor	Date corrector operating lever
1128	53.080	2576	Sautoir de quantième	Datumraste	Date jumper
1128	91.440		Indicateur de quantième pour ouverture de guichet à 3 heures	Datumanzeiger, für Fenster bei 3 Uhr	Date indicator, for windows opening at 3 o'clock
1128	3500	52535	2x Vis de plaque de maintien de l'indicateur de quantième	Schraube für Halteplatte für Datumanzeiger	Screw for date indicator maintaining plate
1128	3501	52595	1x Vis de plaque de maintien de sautoir de quantième	Schraube für Halteplatte für Datumraste	Screw for date jumper maintaining plate
1128	3502	59448	3x Vis de planche du mécanisme d'affichage	Schraube für Gestell für Zeitanzeigermechanismus	Screw for display mechanism platform

Aiguillage – Zeigerwerkhöhe – Hand fitting height

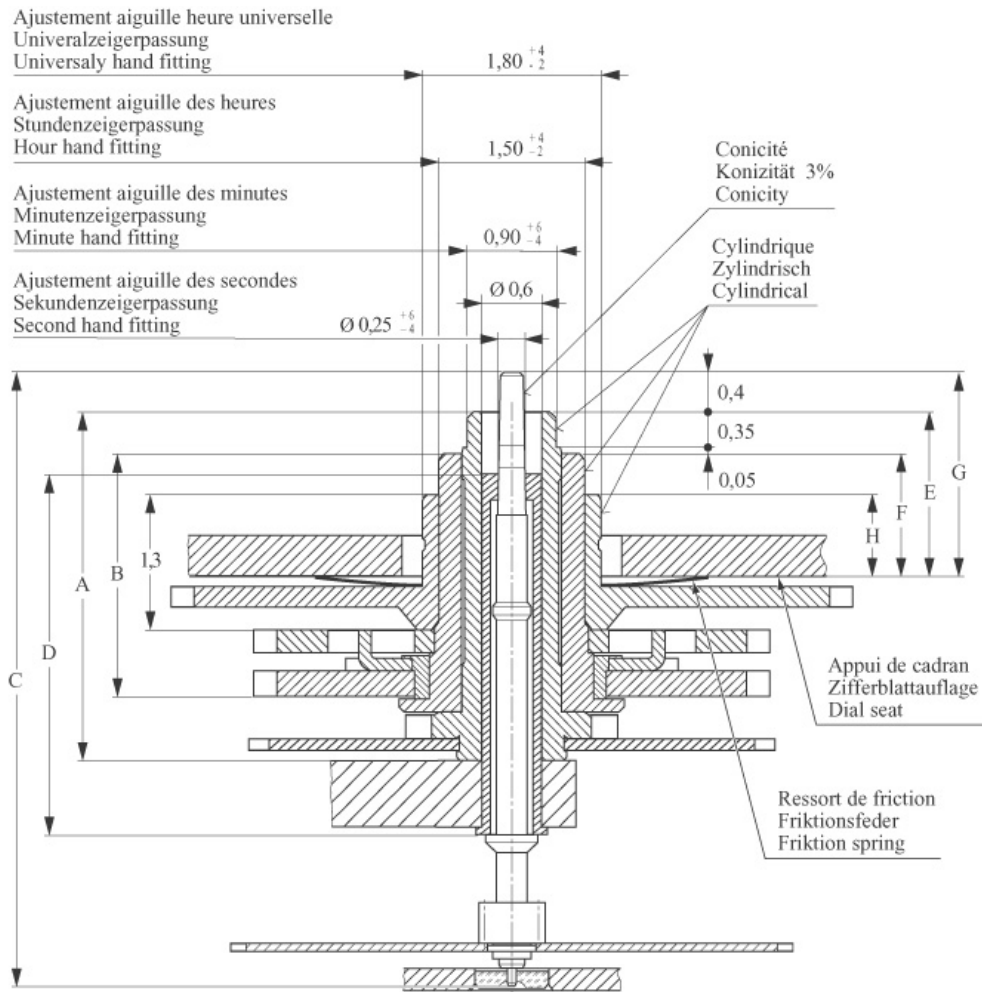

Aiguillage Zeigerwerk höhe Hand fitting height	Longueur / Länge / Lenght (mm)				Dépassement platine en mm Höhe ab Werkplatte in mm Overstepping main plate in mm				
	Chaussée Minutenrohr Cannon- pinion	Roue des heures Stundenrad Hour wheel	Pignon des secondes Sekunden- trieb Sec. wheel pinion	Indicateur d'heures (24h) Stunden anzeiger (24h) Hour indicator (24h)	Tube de centre Zentrumrohr Center tube	Chaussée Minutenrohr Cannon- pinion	Roue des heures Stundenrad Hour wheel	Pignon des secondes Sekunden- trieb Sec. wheel pinion	Indicateur d'heures (24h) Stunden anzeiger (24h) Hour indicator (24h)
H1	3,40	2,54	6,11	1,30	3,50	1,60	1,20	2,00	0,80
H2	3,65	2,79	6,36	1,55	3,50	1,85	1,45	2,25	1,05
H3	3,9	3,04	6,61	1,80	3,50	2,10	1,70	2,50	1,3

